



LIGHT EMITTING DIODE SPECIFICATION

Revise History

Rev.	Descriptions	Date	Page
1.0	-	23-10-2017	-
2.0	Renew form	15-12-2018	-
2.1	Renew form	10-11-2020	-
2.2	Renew form	27-11-2023	-

Contains trade secret information which is the property of Ekinglux and shall not be made available to, or copied or used by anyone outside Ekinglux without its written authorization. Copyright © 2017 Ekinglux Optoelectronics Technology Co., Ltd. All rights reserved.

Features:

- Long operating life
- Low Power Consumption
- Wide Viewing Angle
- Low voltage DC operated
- RoHS Compliant
- Moisture sensitivity level: 3

Application:

- Backlight, Decoration lighting, motormeter, Indicator

Part Number	Dice Material	Emitted Color	Lens Color
E6C0805YGAC1UDA	AlGaInP	Yellow Green	Water Clear

Electro-Optical Characteristics($T_a=25^{\circ}\text{C}$)

Parameter	Symbol	Min.	Typ.	Max.	Unit	Test Condition
Luminous Intensity ^{*1}	IV	10	30	70	mcd	IF=20mA
Radiation Bandwidth	$\Delta\lambda$	-	30	-	nm	
Forward Voltage	VF	1.80	2.00	2.40	v	
Peak Wavelength	λ_p	-	573	-	nm	
Dominant Wavelength ^{*3}	λ_d	565	570	575	nm	
Viewing Angle ^{*2}	$2\theta_{1/2}$	-	120	-	deg	VR=5V
Reverse Current	IR	-	-	10	uA	

Notes:

1. ALuminous intensity is measured with a light sensor and filter combination that approximates the CIE eye-response curve.
2. $2\theta_{1/2}$ is the o -axis angle where the luminous intensity is 1/2 the peak intensity
3. The dominant wavelength (λ_d) is derived from the CIE chromaticity diagram and represents the single wavelength which defines the color of the device

Absolute Maximum Ratings($T_a=25^{\circ}\text{C}$)

Parameter	Symbol	Max.	Unit
Power Dissipation	Pd	60	mW
Peak Forward Current ^{*1}	IFP	100	mA
Forward Current	IF	25	mA
Reverse Voltage	VR	5	v
Electrostatic Discharge	ESD	2000	v
Operating Temperature Range	Topr	-40to+85	$^{\circ}\text{C}$
Storage Temperature Range	Tstg	-40to+90	$^{\circ}\text{C}$
Reflow Soldering	Tsld	260 $^{\circ}\text{C}$ for 5secs	

Notes: 1. Duty Factor = 10%, Frequency = 1 kHz



Optical & Electrical Characteristics

Relative Intensity vs. Wavelength

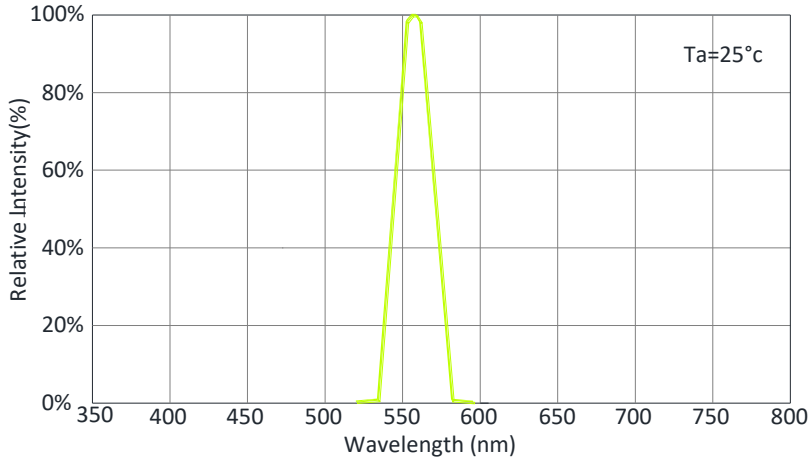

Forward Current vs. Forward Voltage

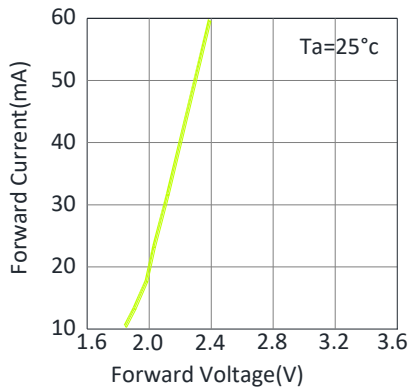

Maximum Driving Forward DC Current vs. Ambient Temperature (De-rating based on Tj max.=115°C)

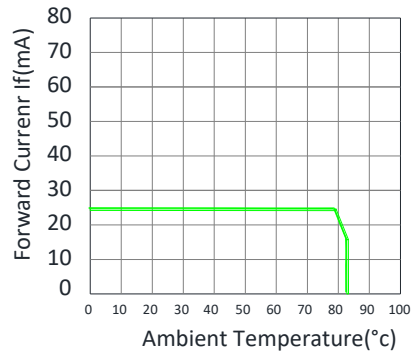

Relative Intensity vs. Forward Current

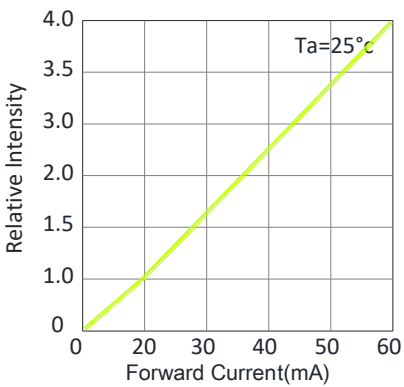

Relative Intensity vs. Ambient Temperature

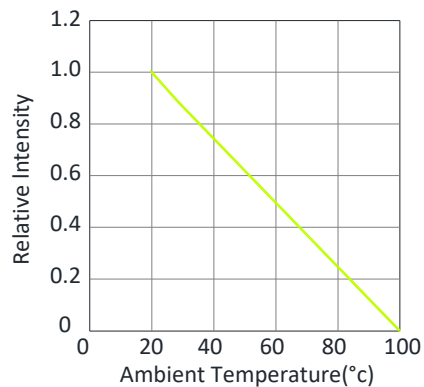

Radiation Pattern

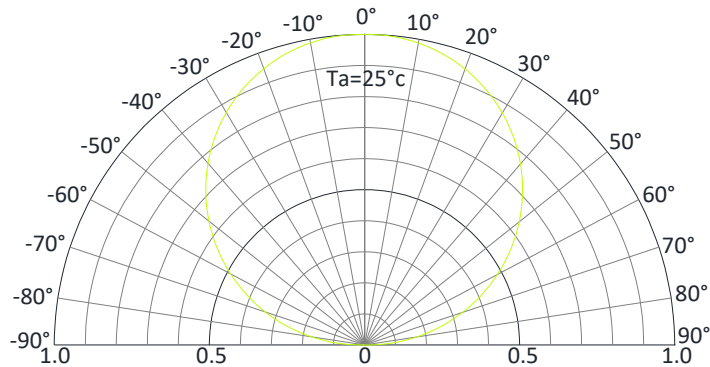



Bin Limits

Bin Range Of Luminous Intensity (Unit:mcd)

Bin Code	Min	Max	Condition
L1	10	30	IF=20mA
L2	30	50	
L3	50	70	

Bin Range Of Forward Voltage (Unit:V)

Bin Code	Min	Max	Condition
V1	1.8	2.0	IF=20mA
V2	2.0	2.2	
V3	2.2	2.4	
V4	-	-	
V5	-	-	

Bin Range Of Wavelength (Unit:nm)

Bin Code	Min	Max	Condition
YG1	565	567	IF=20mA
YG2	567	569	
YG3	569	571	
YG4	571	573	
YG5	573	575	

Notes:

- 1.Luminous flux measurement tolerance: ±10%.
- 2.Wavelength measurement tolerance: ±1nm.
- 3.Forward voltage measurement tolerance: ±0.1V.

**Reliability Test Items And Conditions**

Test Items	Reference	Test Conditions	Time	Quantity	Criterion
Thermal Shock	MIL-STD-202G	-40°C (30min) -100°C (30min)	100 Cycles	22	0/22
Temperature And Humidity Cyclic	JEITA ED-4701 200 203	-10°C~65°C ; 0%~90%RH	10cycles	22	0/22
High Temperature Storage	JEITA ED -4071 200 201	Ta=100°C	1000H	22	0/22
Low Temperature Storage	JEITA ED -4071 200 202	Ta=-40°C	1000H	22	0/22
High Temperature High Humidity Storage	JEITA ED -4071 100 103	Ta=85°C RH=85%	1000H	22	0/22
High Temperature Life Test	JESD22-A108D	Ta=80°C	1000H	22	0/22
Life Test	JESD22-A108D	Ta=25°C IF=5mA	1000H	22	0/22
Resistance to Sodering Heat	GB/T 4937, II , 2.2&2.3	Tsol*=(240±5) °C 10secs	2 times	22	0/22

Criteria For Judging Damage

Test Items	Symbol	Test Conditions	Criteria For Judging Damage
Forward Voltage	V _F	I _F =I _{FT}	Initial Data±10%
Recerse Current	I _R	V _R =5V	I _R ≤10uA
Luminous Intensity	I _V	I _F =I _{FT}	Average I _V degradation≤30% ; Single LED I _V degradation≤50%
Resistance to Soldering Heat	-	-	Material without internal cracks,no material between stripped,no deaded light

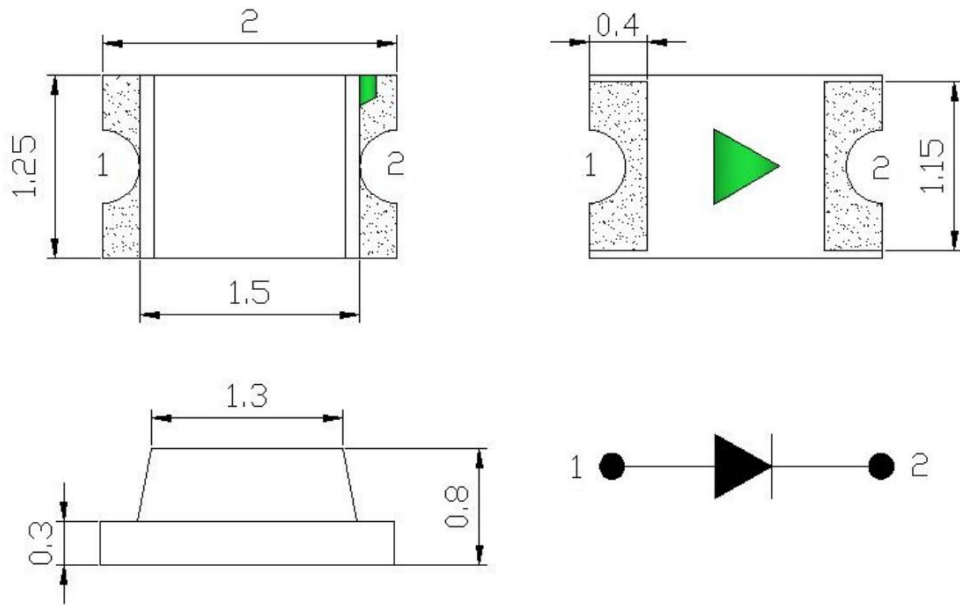
Product size (Unit:mm)

NOTES :

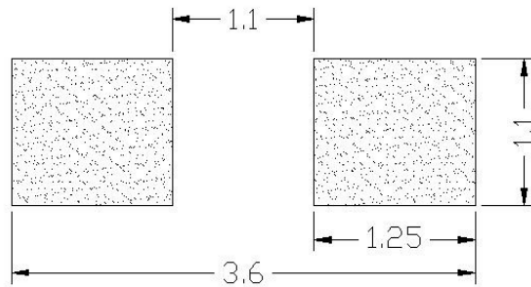
1. All dimensions are in millimeters (inches)
2. Tolerances are $\pm 0.2\text{mm}$ (0.008inch) unless otherwise noted

Recommended Soldering Pad Design (Unit:mm)

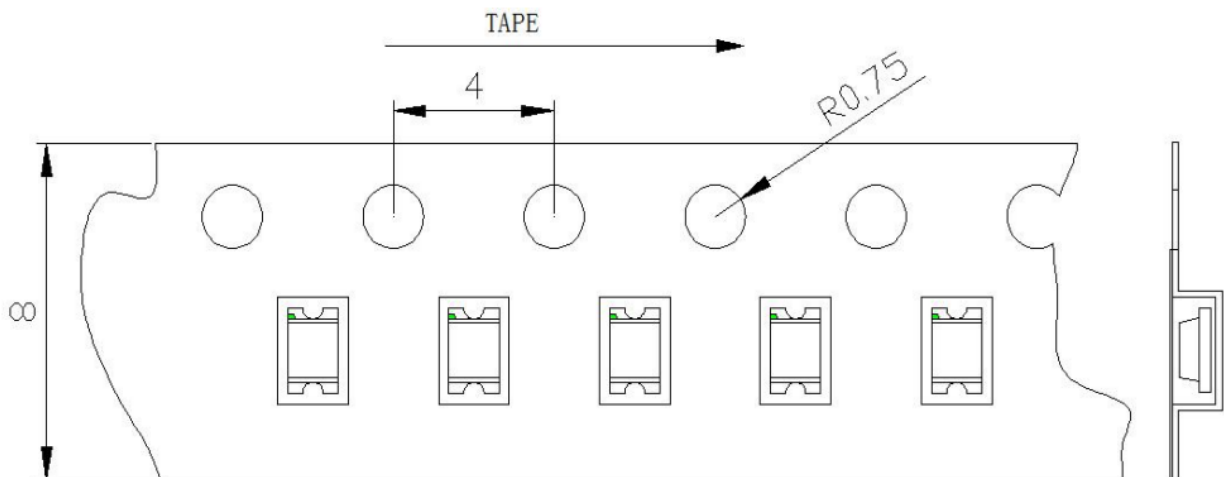
Taping and package Spec

- Tape Specification: 3,000pcs Per Reel





Packaging



LabelStyle

EKINGLUX OPTOELECTRONICS(SHANGHAI) CO.,LTD
 Tel:021 59909181 <http://www.ekingluxs.com>

 PN:XXXXXXXXXXXXXXXXXX

Emitting Color: XXXX	
HUE: XXX-XXX	
IV : XXX-XXX	
VF: XX-XX	SN: XX
QTY: XXXX PCS	DATE: XXXX/XX/XX



 LOT NO.:XXXXXXXXXX

Table of Classification Reflow Profiles

Profile Feature	Sn-Pb Eutectic Assembly	Pb-Free Assembly
Preheat & Soak	100 °C	150 °C
Temperature min (T _{smin})	150°C	200 °C
Temperature max (T _{smax})	60-120 seconds	60-120 seconds
Time (T _{smin} to T _{smax}) (t _s)		
Average ramp-up rate (T _{smax} to T _p)	3 °C/second max	3 °C/second max
Liquidous temperature (T _L)	183 °C	217 °C
Time at liquidous (t _L)	60-150 seconds	60-150 seconds
Peak package body temperature (T _p)*	230 °C ~235 °C	255 °C ~260 °C
Classification temperature (T _c)	235 °C	260 °C
Time (t _p) within 5 °C of the specified Classification temperature (T _c)	20 seconds	30 seconds
Average ramp-down rate (T _p to T _{smax})	6 °C/second max	6 °C/second max
Time 25 °C to peak temperature	6 minutes max	8 minutes max

1. Tolerance for peak profile temperature (T_p) is defined as a supplier minimum and a user maximum.
2. Tolerance for time at peak profile temperature (t_p) is defined as a supplier minimum and a user maximum.

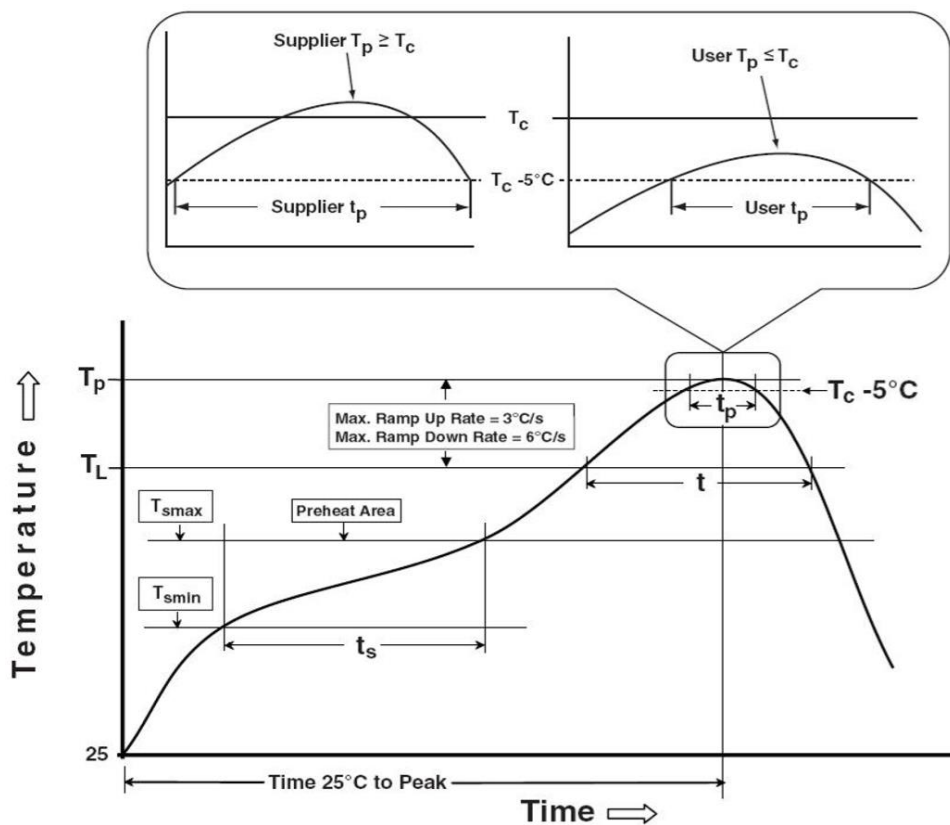

Precautions

1. Storage:

- Moisture proof and anti-electrostatic package with moisture absorbent material is used, to keep moisture to a minimum.
- Before opening the package, the product should be kept at 30°C or less and humidity less than 60% RH, and be used within a year.
- After opening the package, the product should be stored at 30°C or less and humidity less than 10%RH. It is recommended that the product be operated at the workshop condition of 30°C or less and humidity less than 60%RH.
- If the moisture absorbent material has faded away or the LEDs have exceeded the storage time, baking treatment should be performed based on the following condition: (70±5)°C for 24 hours.

2. Static Electricity:

- Static electricity or surge voltage damages the LEDs. Damaged LEDs will show some unusual characteristics such as the forward voltage becoming lower, or the LEDs do not light at the low current. All devices, equipment and machinery must be properly grounded. At the same time, it is recommended that wrist bands or anti-electrostatic gloves, anti-electrostatic containers be used when dealing with the LEDs.

3. Vulcanization:

- LED curing is due to sulfur being in brackets and the +1 price of silver in the chemical reaction generated Ag₂S in the process. It will lead to the capacity of reflecting of silver layer reducing, light color temperature drift and serious decline, seriously affecting the performance of the product. So we should take corresponding measures to avoid vulcanization, such as to avoid using sulphur volatile substances and keeping away from high sulphur content of the material.

4. Handling Precautions:

- Handle the component along the side surfaces by using forceps or appropriate tools.
- Do not directly touch or handle the epoxy resin lens surface. It may damage the internal circuitry.
- Do not stack together assembled PCBs containing exposed LEDs. Impact may scratch the epoxy resin lens or damage the internal circuitry.

