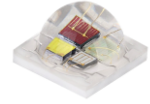

# LIGHT EMITTING DIODE SPECIFICATION

DESCRIPTION:	E6T5050RGBWC4UDA
REVISION:	V2.2
ISSUE DATE:	2019-01-18

Contains trade secret information which is the property of Ekinglux and shall not be made available to, or copied or used by anyone outside Ekinglux without its written authorization. Copyright © 2017 Ekinglux Optoelectronics Technology Co., Ltd. All rights reserved

**Features:**

- Long operating life
- Super high Flux output and high Luminance
- Wide Viewing Angle
- RoHS Compliant

**Application:**

- Caution light
- Decoration lighting
- Automobile lamps
- Indicator
- outdoor lighting

Part Number	Dice Material	Emitted Color	Lens Color
E6T5050RGBWC4UDA	AlGaInP-InGaN-InGaN -InGaN	Red-Green-Blue-White	Water Clear

**Electro-Optical Characteristics** (Ta=25°C, @350mA)

Parameter	Color	Symbol	Min.	Typ.	Max.	Unit
Luminous Flux	R	Φ	40	50	70	lm
	G		100	120	150	
	B		15	20	30	
	W		120	130	160	
Forward Voltage	R	VF	1.90	2.00	2.40	v
	G		2.90	3.00	3.40	
	B		2.90	3.00	3.40	
	W		2.90	3.00	3.40	
Dominant Wavelength	R	λd	620	625	630	nm
	G		520	525	530	
	B		450	460	470	
	W		2800-3500	3600-4800	5800-6700	k
Viewing Angle	-	2θ1/2	-	120	-	deg
Reverse Current	-	IR	-	-	10	uA

**Absolute Maximum Ratings** (Ta=25°C)

Parameter	Symbol	Max.	Unit
Peak Forward Current(1/10 Duty Cycle, 0.1ms Pulse Width)	IFP	1000	mA
Forward Current	IF	350	mA
Reverse Voltage	VR	5	v
Electrostatic Discharge	ESD	2000	v
Operating Temperature Range	Topr	-40to+90	°C
Storage Temperature Range	Tstg	-40to+90	°C
Reflow Soldering	Tsld	260°C for 10secs	



### Optical & Electrical Characteristics

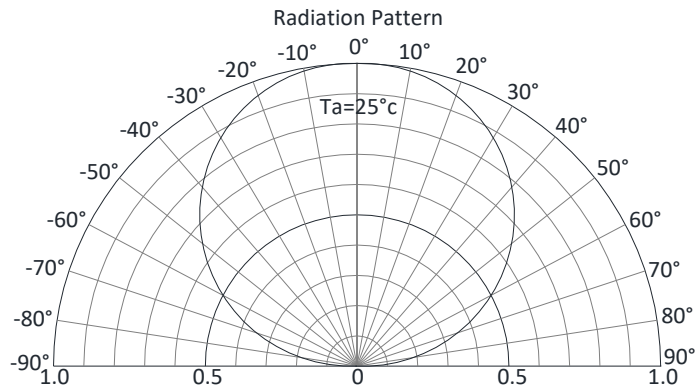
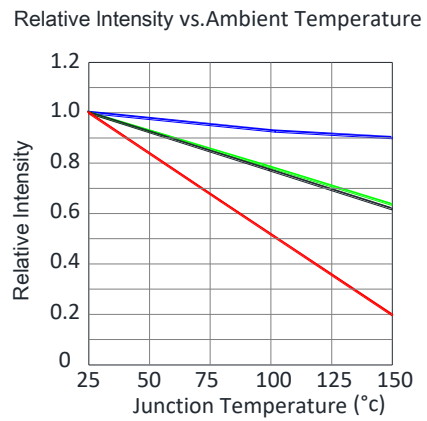
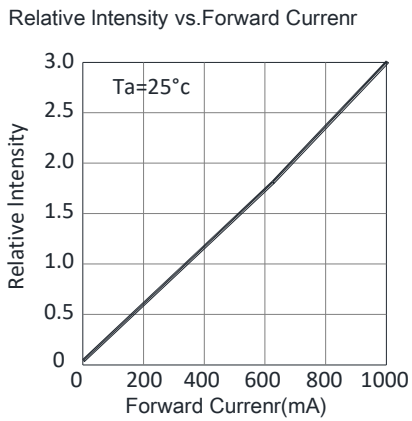
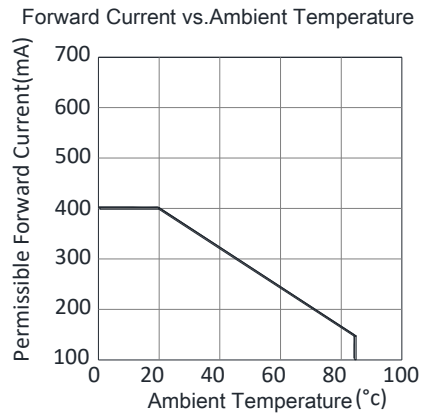
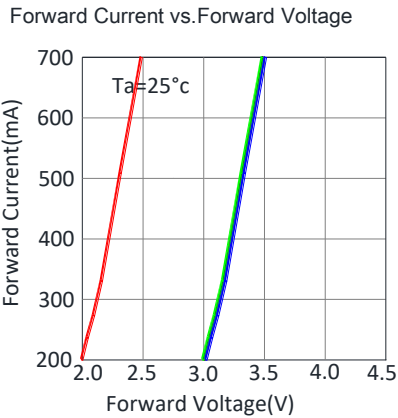
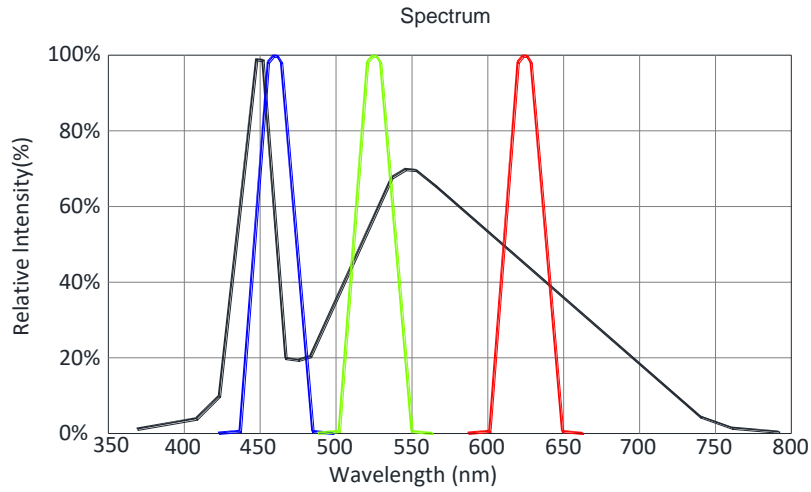



### CIE Chromaticity Diagram@ Warm White

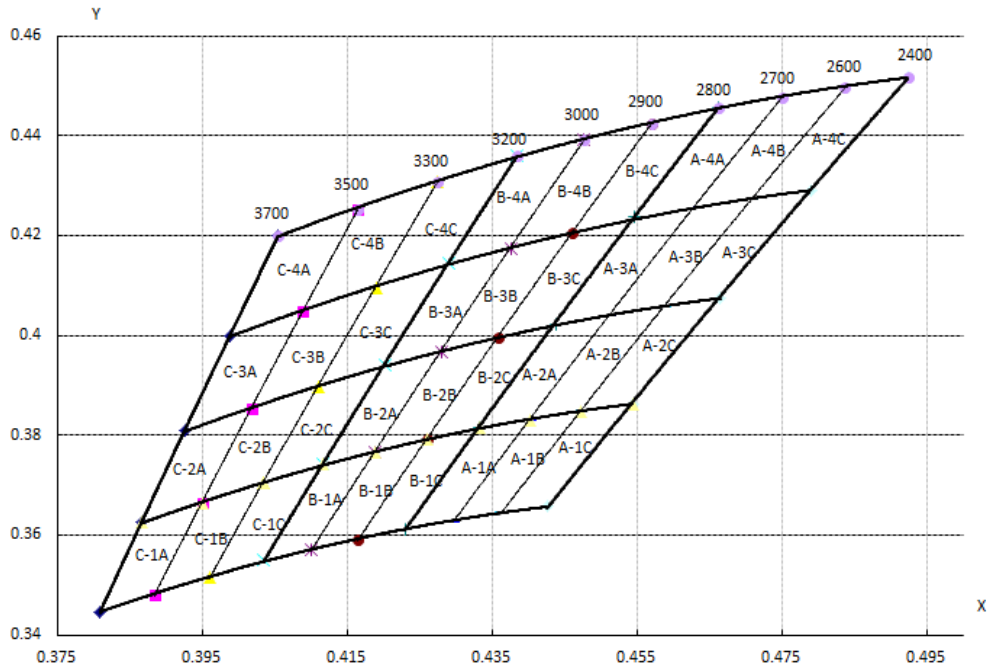

### Color Bin Limits

Code	X1	Y1	X2	Y2	X3	Y3	X4	Y4
A-4A	0.4662	0.4457	0.4547	0.4236	0.4628	0.4254	0.4750	0.4477
A-3A	0.4547	0.4236	0.4438	0.4023	0.4513	0.4040	0.4628	0.4254
A-2A	0.4438	0.4023	0.4332	0.3815	0.4403	0.3831	0.4513	0.4040
A-1A	0.4332	0.3815	0.4230	0.3612	0.4296	0.3627	0.4403	0.3831
B-4C	0.4570	0.4425	0.4461	0.4205	0.4547	0.4236	0.4662	0.4457
B-3C	0.4461	0.4205	0.4359	0.3995	0.4438	0.4023	0.4547	0.4236
B-2C	0.4359	0.3995	0.4260	0.3791	0.4332	0.3815	0.4438	0.4023
B-1C	0.4260	0.3791	0.4165	0.3591	0.4230	0.3612	0.4332	0.3815
B-4B	0.4477	0.4393	0.4376	0.4174	0.4461	0.4205	0.4570	0.4425
B-3B	0.4376	0.4174	0.4281	0.3967	0.4359	0.3995	0.4461	0.4205
B-2B	0.4281	0.3967	0.4189	0.3766	0.4260	0.3791	0.4359	0.3995
B-1B	0.4189	0.3766	0.4100	0.3571	0.4165	0.3591	0.4260	0.3791
B-4A	0.4384	0.4360	0.4290	0.4143	0.4376	0.4174	0.4477	0.4393
B-3A	0.4290	0.4143	0.4202	0.3939	0.4281	0.3967	0.4376	0.4174
B-2A	0.4202	0.3939	0.4117	0.3741	0.4189	0.3766	0.4281	0.3967
B-1A	0.4117	0.3741	0.4035	0.3550	0.4100	0.3571	0.4189	0.3766



### CIE Chromaticity Diagram@ Natural White

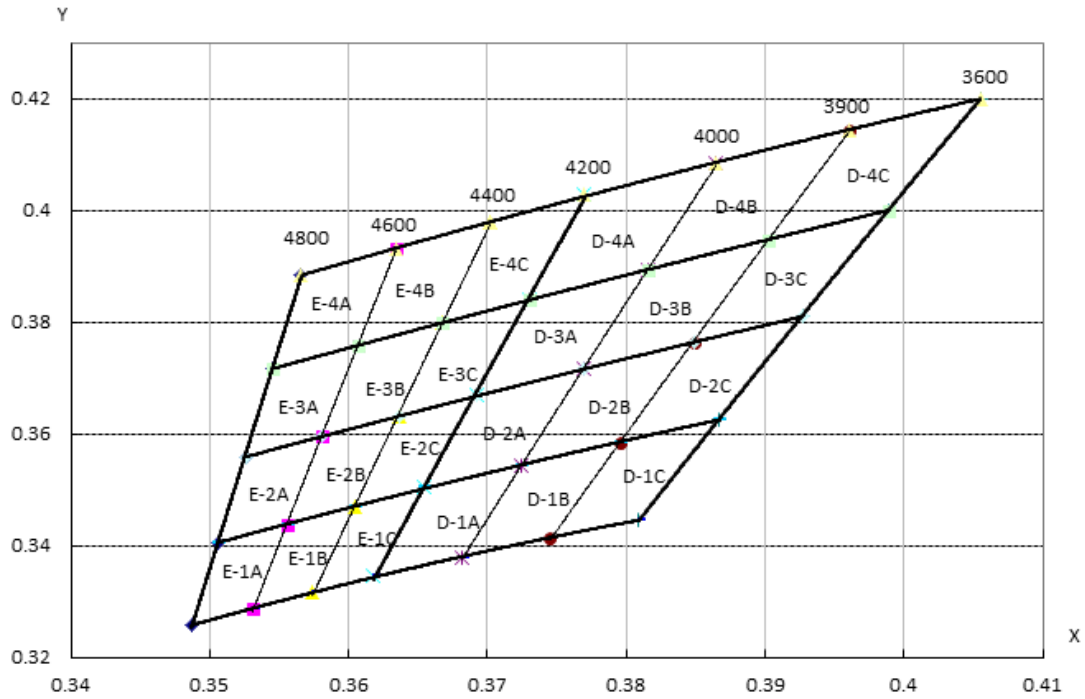

### Color Bin Limits

Code	X1	Y1	X2	Y2	X3	Y3	X4	Y4
D-4C	0.3960	0.4142	0.3903	0.3947	0.3989	0.4000	0.4055	0.4200
D-3C	0.3903	0.3947	0.3849	0.3763	0.3927	0.3810	0.3989	0.4000
D-2C	0.3849	0.3763	0.3796	0.3585	0.3867	0.3625	0.3927	0.3810
D-1C	0.3796	0.3585	0.3745	0.3412	0.3809	0.3446	0.3867	0.3625
D-4B	0.3865	0.4084	0.3816	0.3893	0.3903	0.3947	0.3960	0.4142
D-3B	0.3816	0.3893	0.3770	0.3715	0.3849	0.3763	0.3903	0.3947
D-2B	0.3770	0.3715	0.3725	0.3544	0.3796	0.3585	0.3849	0.3763
D-1B	0.3725	0.3544	0.3682	0.3379	0.3745	0.3412	0.3796	0.3585
D-4A	0.3770	0.4027	0.3730	0.3840	0.3816	0.3893	0.3865	0.4084
D-3A	0.3730	0.3840	0.3692	0.3668	0.3770	0.3715	0.3816	0.3893
D-2A	0.3692	0.3668	0.3655	0.3503	0.3725	0.3544	0.3770	0.3715
D-1A	0.3655	0.3503	0.3618	0.3345	0.3682	0.3379	0.3725	0.3544



CIE Chromaticity Diagram@ Cool White

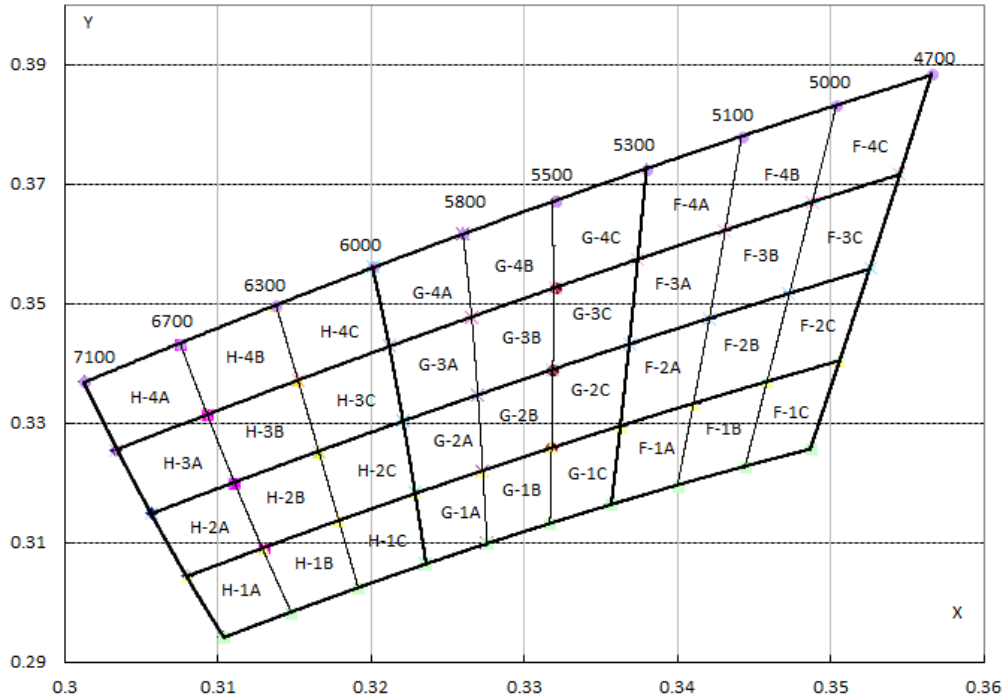

Color Bin Limits

Code	X1	Y1	X2	Y2	X3	Y3	X4	Y4
H-4C	0.3138	0.3497	0.3153	0.3371	0.3212	0.3429	0.3201	0.3562
H-3C	0.3153	0.3371	0.3166	0.3252	0.3221	0.3304	0.3212	0.3429
H-2C	0.3166	0.3252	0.3179	0.3136	0.3229	0.3183	0.3221	0.3304
H-1C	0.3179	0.3136	0.3192	0.3024	0.3236	0.3065	0.3229	0.3183
H-4B	0.3076	0.3432	0.3093	0.3313	0.3153	0.3371	0.3138	0.3497
H-3B	0.3093	0.3313	0.3111	0.3200	0.3166	0.3252	0.3153	0.3371
H-2B	0.3111	0.3200	0.3130	0.3090	0.3179	0.3136	0.3166	0.3252
H-1B	0.3130	0.3090	0.3148	0.2982	0.3192	0.3024	0.3179	0.3136
H-4A	0.3013	0.3368	0.3034	0.3255	0.3093	0.3313	0.3076	0.3432
H-3A	0.3034	0.3255	0.3057	0.3148	0.3111	0.3200	0.3093	0.3313
H-2A	0.3057	0.3148	0.3080	0.3043	0.3130	0.3090	0.3111	0.3200
H-1A	0.3080	0.3043	0.3104	0.2941	0.3148	0.2982	0.3130	0.3090

**Reliability Test Items And Conditions**

Test Items	Reference	Test Conditions	Time	Quantity	Criterion
Thermal Shock	MIL-STD-202G	-40°C (30min) -100°C (30min)	100 Cycles	22	0/22
Temperature And Humidity Cyclic	JEITA ED-4701 200 203	-10°C~65°C ; 0%~90%RH	10cycles	22	0/22
High Temperature Storage	JEITA ED -4071 200 201	Ta=100°C	1000H	22	0/22
Low Temperature Storage	JEITA ED -4071 200 202	Ta=-40°C	1000H	22	0/22
High Temperature High Humidity Storage	JEITA ED -4071 100 103	Ta=60°C ; RH=90%	1000H	22	0/22
High Temperature Life Test	JESD22-A108D	Ta=80°C	1000H	22	0/22
Life Test	JESD22-A108D	Ta=25°C IF=350mA	1000H	22	0/22
Resistance to Soldering Heat	GB/T 4937, II , 2.2&2.3	Tsol*=(240±5) °C 10secs	2 times	22	0/22

**Criteria For Judging Damage**

Test Items	Symbol	Test Conditions	Criteria For Judging Damage
Forward Voltage	V <sub>F</sub>	I <sub>F</sub> =I <sub>FT</sub>	Initial Data±10%
Reverse Current	I <sub>R</sub>	V <sub>R</sub> =5V	I <sub>R</sub> ≤10uA
Luminous Intensity	I <sub>V</sub>	I <sub>F</sub> =I <sub>FT</sub>	Average I <sub>V</sub> degradation≤30% ; Single LED I <sub>V</sub> degradation≤50%
Resistance to Soldering Heat	-	-	Material without internal cracks,no material between stripped,no dead light

### Product size (Unit:mm)

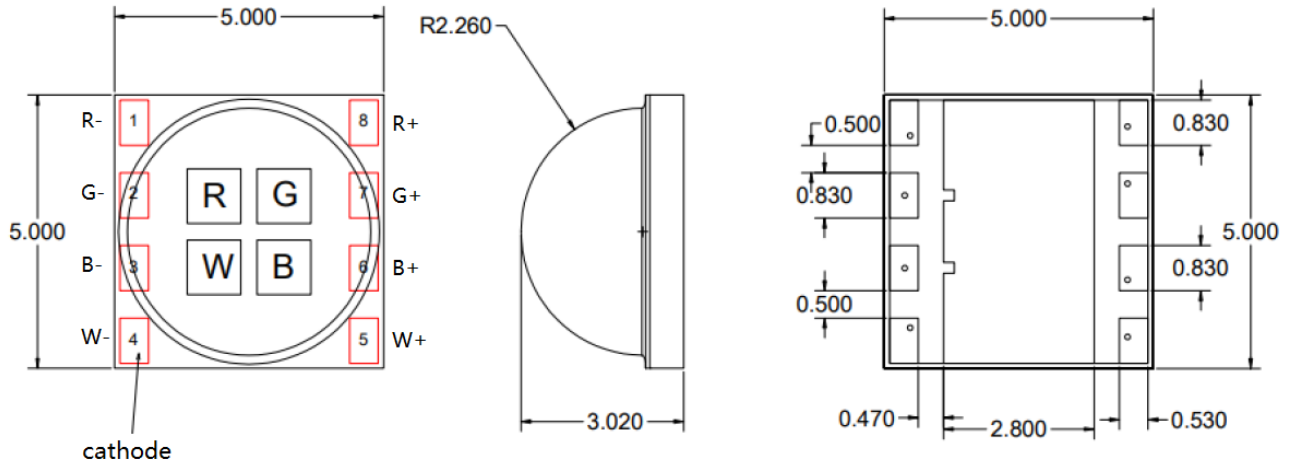

NOTES :

1. All dimensions are in millimeters (inches)
2. Tolerances are  $\pm 0.2\text{mm}$  (0.008inch) unless otherwise noted

### Recommended Soldering Pad Design (Unit:mm)

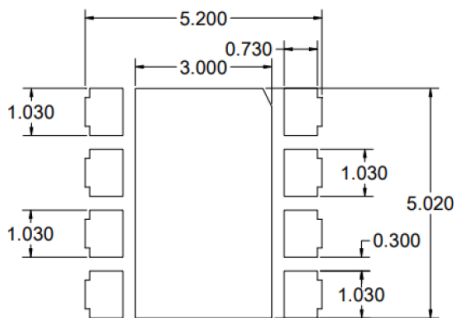

PCB pad design recommendations

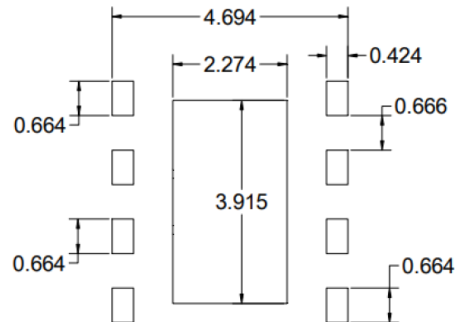

Stencil design suggestions

### Taping and package Spec

- Tape Specification:1,000pcs Per Reel

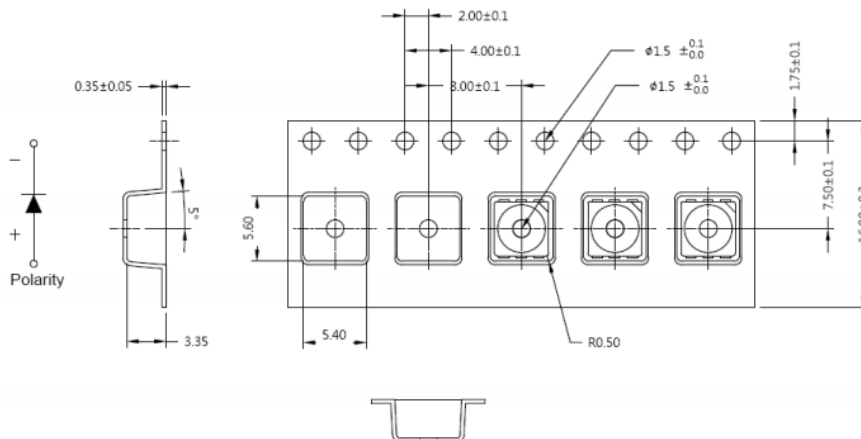



### Packaging

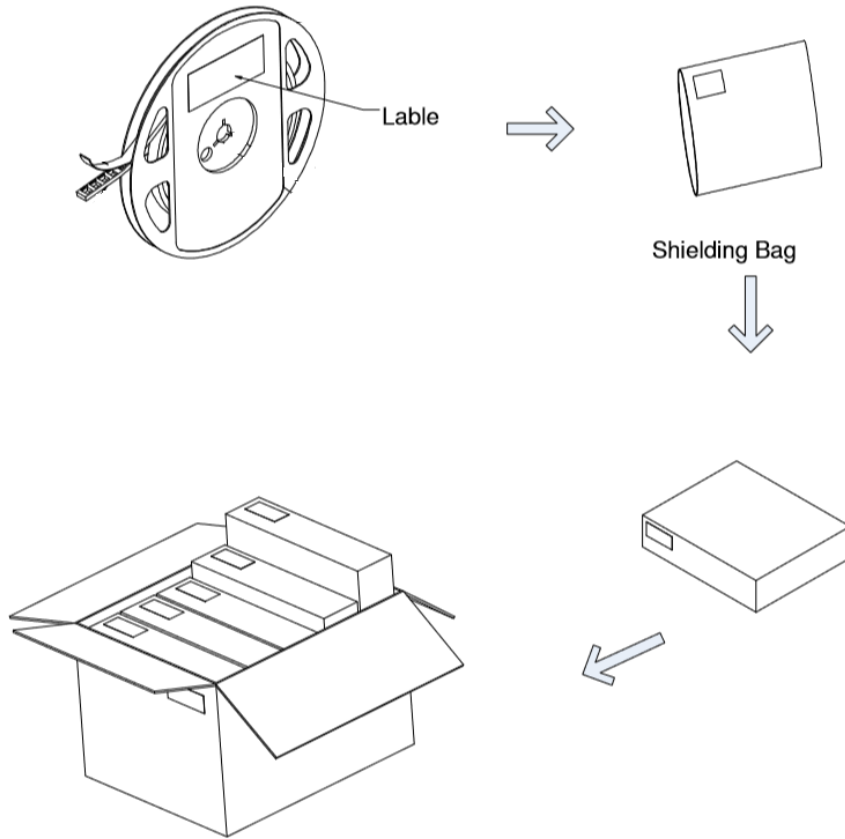

### LabelStyle

EKIINGLUX OPTOELECTRONICS(SHANGHAI) CO.,LTD  
 TEL:86 21 59909181      Sales@ekingluxs.com

  
 P/N:XXXXXXXXXXXXXXXXXX

Emitting Color: XXXX  
 HUE: XXX-XXX nm  
 IV : XXX-XXX mcd **example**  
 VF: XX-XX V  
 QTY: XX PCS

  
 BIN Code: XX  
 DATE: XXXX/XX/XX

  
 LOT NO.:XXXXXXX

**Table of Classification Reflow Profiles**

Profile Feature	Sn-Pb Eutectic Assembly	Pb-Free Assembly
Preheat & Soak	100 °C	150 °C
Temperature min (T <sub>smin</sub> )	150°C	200 °C
Temperature max (T <sub>smax</sub> )	60-120 seconds	60-120 seconds
Time (T <sub>smin</sub> to T <sub>smax</sub> ) (t <sub>s</sub> )		
Average ramp-up rate (T <sub>smax</sub> to T <sub>p</sub> )	3 °C/second max	3 °C/second max
Liquidous temperature (T <sub>L</sub> )	183 °C	217 °C
Time at liquidous (t <sub>L</sub> )	60-150 seconds	60-150 seconds
Peak package body temperature (T <sub>p</sub> )*	230 °C ~235 °C	255 °C ~260 °C
Classification temperature (T <sub>c</sub> )	235 °C	260 °C
Time (t <sub>p</sub> ) within 5 °C of the specified Classification temperature (T <sub>c</sub> )	20 seconds	30 seconds
Average ramp-down rate (T <sub>p</sub> to T <sub>smax</sub> )	6 °C/second max	6 °C/second max
Time 25 °C to peak temperature	6 minutes max	8 minutes max

1. Tolerance for peak profile temperature (T<sub>p</sub>) is defined as a supplier minimum and a user maximum.
2. Tolerance for time at peak profile temperature (t<sub>p</sub>) is defined as a supplier minimum and a user maximum.

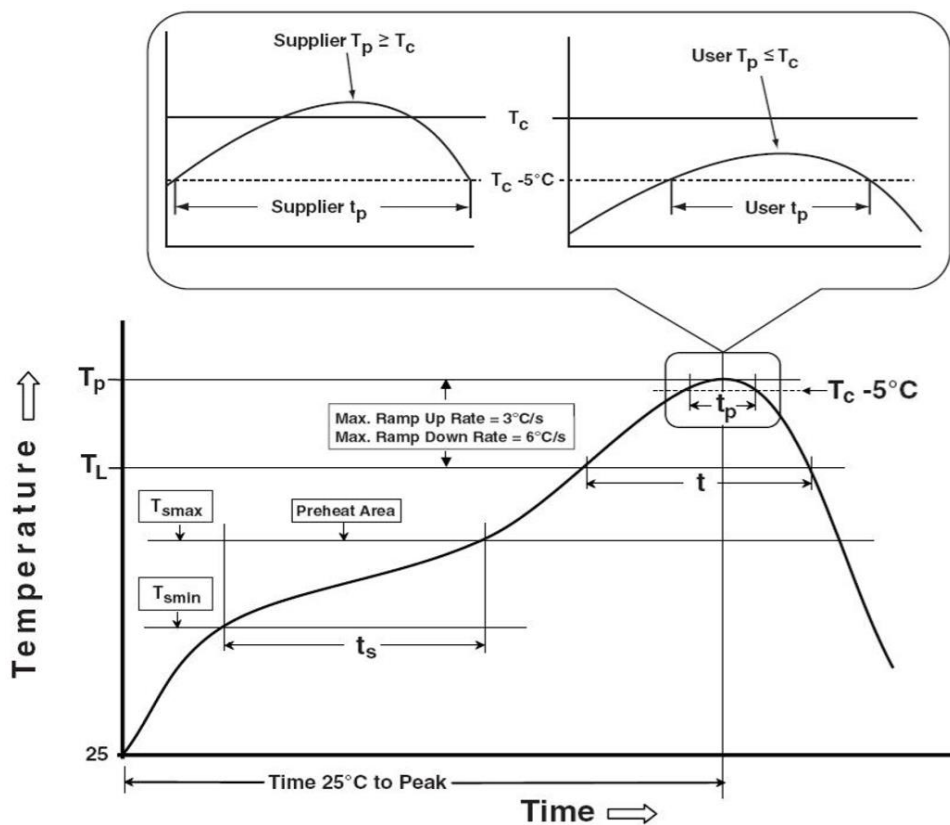

## Precautions

### 1. Storage:

- Moisture proof and anti-electrostatic package with moisture absorbent material is used, to keep moisture to a minimum.
- Before opening the package, the product should be kept at 30°C or less and humidity less than 60% RH, and be used within a year.
- After opening the package, the product should be stored at 30°C or less and humidity less than 10%RH. It is recommended that the product be operated at the workshop condition of 30°C or less and humidity less than 60%RH.
- If the moisture absorbent material has faded away or the LEDs have exceeded the storage time, baking treatment should be performed based on the following condition: (70±5)°C for 24 hours.

### 2. Static Electricity:

Static electricity or surge voltage damages the LEDs. Damaged LEDs will show some unusual characteristics such as the forward voltage becoming lower, or the LEDs do not light at the low current, even not light.

All devices, equipment and machinery must be properly grounded. At the same time, it is recommended that wrist bands or anti-electrostatic gloves, anti-electrostatic containers be used when dealing with the LEDs.

### 3. Vulcanization:

LED curing is due to sulfur being in brackets and the +1 price of silver in the chemical reaction generated Ag<sub>2</sub>S in the process. It will lead to the capacity of reflecting of silver layer reducing, light color temperature drift and serious decline, seriously affecting the performance of the product. So we should take corresponding measures to avoid vulcanization, such as to avoid using sulphur volatile substances and keeping away from high sulphur content of the material.